

This manual should be considered a permanent part of the motorcycle and should remain with the motorcycle when resold or otherwise transferred to a new owner or operator. The manual contains important safety information and instructions which should be read carefully before operating the motorcycle.

FOREWORD

THANK YOU for choosing **Hyosung** motorcycle. We at **Hyosung** have designed, tested and produced this motorcycle using the most modern technology available to provide you with much happy, enjoyable, safe riding. Motorcycling is one of the most exhilarating sports and insure your riding enjoyment, you should become thoroughly familiar with the information presented in this Owner's Manual before riding the motorcycle.

The proper care and maintenance that your motorcycle requires are outlined in this manual.

By following these instructions explicitly you will insure a long trouble-free operating life for your motorcycle. Your **Hyosung** dealer has experienced technicians that are trained to provide your machine with the best possible service with the right tools and equipment.

All information, illustrations photographs and specifications contained in this manual are based on the latest product information available at the time of publication. Due to improvements or other changes, there may be some discrepancies in this manual. Hyosung reserves the right to make changes at any time.

Please note that this manual applies to all specifications for all respective destinations and explains all equipments. Therefore, your model may have different standard features than shown in this manual.

 HYOSUNG MOTORS & MACHINERY INC.

© COPYRIGHT HYOSUNG MOTORS & MACHINERY INC.

IMPORTANT

BREAK-IN INFORMATION FOR YOUR MOTORCYCLE

The first 1,600km(1,000miles) are the most important in the life of your motorcycle.

Proper break-in operation during this time will help ensure maximum life and performance from your new motorcycle.

Hyosung parts are manufactured of high quality materials, and manufactured parts are finished to close tolerances. Proper break-in operation allows the machined surfaces to polish each other and mate smoothly.

Motorcycle reliability and performance depend on special care and restraint exercise during the break-in period. It is especially important that you avoid operating the engine in a manner which could expose the engine parts to excessive heat.

Please refer to the BREAK-IN section for specific break-in recommendations.

WARNING/CAUTION/NOTE

Please read this manual and follow its instructions carefully. To emphasize special information the words 『WARNING』, 『CAUTION』 and 『NOTE』.



WARNING

The personal safety of the rider may be involved. Disregarding this information could result in injury to the rider.



CAUTION

These instructions point out special service procedures or precautions that must be followed to avoid damaging the machine.

NOTE

This provides special information to make maintenance easier or important instructions clearer.



WARNING

Noise Control System(muffler assembly)

TAMPERING WITH NOISE CONTROL SYSTEM PROHIBITED

Owners are warned that the law may prohibit :

- (a) The removal or rendering inoperative by any person other than for the purpose of maintenance, repair or replacement, of any device or element of design incorporated into any new vehicle for the purpose of noise control prior to its any sale or delivery to the ultimate purchaser or while it is in use ; and**
- (b) The use of the vehicle after such device or element of design has been removed or rendered inoperative by any person.**

MAINTENANCE:

The exhaust system of this motorcycle requires no periodic maintenance.

The engine should be adjusted to the manufacture' s specifications and the spark plug should be kept in good condition. Running the engine with incorrectly operating spark plug or misadjusted carburetor may cause permanent damage to the catalyst and to the noise control system.

CONSUMER INFORMATION

SAFE RIDING RECOMMENDATION FOR MOTORCYCLE RIDERS

Motorcycle riding is great fun and an exciting sport. Motorcycle riding also requires that some extra precautions be taken to ensure the safety of the rider and passenger. These precautions are:



WARNING

- Before first use of the *Ray*, read this owner's manual carefully to become familiar with the *Ray*'s features, and safety and maintenance requirements. Review all instructions, requirements and warnings with the riders. Keep the owner's manual in the personal trunk located under the seat.
- Before the rider's first use of the *Ray*, make sure that he / she is familiar with the location and operation of all controls, and has been instructed in the proper operation of the motorcycle.
- For first use of the *Ray*, find a level, open area for the rider to use to become familiar with the operation of controls and the operating and handling characteristics of the *Ray*.



WARNING

- Before each use, perform daily inspections with the rider. Specific items to check are listed in the INSPECTION BEFORE RIDING section on page 33 of this owner's manual.
- Make sure the rider wears a helmet, eye protection, and protective clothing (gloves, leather or heavy cloth pants, long sleeved shirt or jacket, boots).
- Permit use only by dual rider. This motorcycle is designed for use only by dual rider.
- Do not permit anyone to operate the *Ray* under the influence of alcohol or other drugs caused by damage to the motorcycle or altered handling characteristics.
- Observe periodic maintenance requirements your authorized HYOSUNG dealer is trained and equipped to perform this service.
- Drain gasoline from the fuel tank and carburetor prior to transporting the *Ray*.
- Caution the rider and others near the *Ray*, not to get close to or touch any moving parts or any heated areas such as the engine and exhaust system.
- Do not make any modifications to the *Ray*. Modifications may make the motorcycle unsafe or illegal in your state.



WARNING

- Do not run the engine indoors or where there is little or no ventilation. Exhaust gases contain carbon monoxide, a potentially lethal gas that is colorless and odorless.
- Never leave the motorcycle running while unattended, even for a short time.



WARNING

Removing your hands from the handlebars or feet from the footrests during operation can be hazardous. If you remove even one hand or foot from the motorcycle, you can reduce your ability to control the motorcycle.

Always keep both hands on the handlebars and both feet on the footrests of your motorcycle during operation.



WARNING

Always open the throttle gradually to prevent front wheel lifting. Failure to observe this precaution may result in loss of control and an accident.



CAUTION

WHEN KEEPING FOR LONG PERIOD :

1. Supply the enough fuel in the fuel tank.
2. Do drain wholly the fuel in the carburetor.
3. Remove the battery from the motorcycle.





CAUTION

- The trunk could be heated. Don't keep anything that doesn't endure heat.
- Don't keep the fragile.
- Check if it is locked.
- The unlocking of trunk could cause serious accident.
- Don't allow water to get inside the trunk or it could damage.
- Don't keep the valuables in the trunk when leaving unattended.
- Loading limit of helmet holder
: 1.5kg (3.3 lbs)
- Loading limit of personal trunk
: 10kg (22.1 lbs)
- Loading limit of rear carrier
: 5kg (11.0 lbs)
- Exceed loading limit may result in injury caused by damage to the vehicle or altered handling characteristics.



WARNING

Do not operate the ignition switch in the “” (OFF) or “” (LOCK) position or the engine stop switch in the “” position while driving at one’s pleasure.

⦿ WEAR A HELMET



WARNING

Motorcycle safety equipment starts with a quality safety helmet. One of the most serious injuries that can happen is a head injury. **ALWAYS** wear a properly approved helmet. You should also wear a suitable eye protection.

⦿ RIDING APPAREL



WARNING

Loose fancy clothing can be uncomfortable and unsafe in terms of riding your motorcycle. Choose good quality motorcycle riding apparel in terms of riding your motorcycle.

⦿ INSPECTION BEFORE RIDING



WARNING

Review thoroughly the instructions in the “INSPECTION BEFORE RIDING” section of this manual. Do not forget to perform an entire safety inspection to ensure the safety of the rider and its passenger.

⦿ FAMILIARIZE YOURSELF WITH THE MOTORCYCLE



WARNING

Your riding skill and mechanical knowledge from the foundation for safe riding practices.

We suggest that you practice riding your motorcycle in a non-traffic situation until you are thoroughly familiar with your machine and its controls. Remember practice makes perfect.

⦿ KNOW YOUR LIMITS



WARNING

Ride within the boundaries of your own skill at all times. Knowing these limits and staying within them will help you to avoid accidents.

⦿ BE EXTRA SAFETY CONSCIOUS ON BAD WEATHER DAYS



WARNING

Riding on bad weather days, especially wet ones, requires extra caution.

Braking distances double on a rainy day. Stay off of the painted surface marks, manhole covers and greasy appearing areas as they can be especially slippery.

Use extreme caution at railway crossings and on metal gratings and bridges. Whenever you have a doubt about road condition, slow down!

CONSUMER INFORMATION

ACCESSORY INSTALLATION AND PRECAUTION SAFETY TIPS

There are a great variety of accessories available to **Hyosung** owners. **Hyosung** can not have direct control over the quality or suitability of accessories you may wish to purchase except genuine parts.

The addition of unsuitable accessories can lead to unsafe operating conditions. It is not possible for **Hyosung** to test each accessory on the market or combinations of all the available accessories, however, your dealer can assist you in selecting quality accessories and installing them correctly.

Use extreme caution when selecting and installing the accessories for your **Hyosung**. We have developed some general guidelines which will aid you when deciding whether, and how to equip your motorcycle.

1. In case that additional weight or aerodynamic affecting accessories are installed, they should be mounted as low as possible, as close to the motorcycle and as near the center of gravity as is feasible. The mounting brackets and other attachment hardware should be carefully checked to ensure that it provides for a rigid, nonmovable mount. Weak mounts can allow the shifting of the weight and create a dangerous, unstable condition.
2. Inspect for proper ground clearance and bank angle. An improperly mounted load could critically reduce these two safety factors. Also determine that

the “load” does not interfere with the operation of the suspension, steering or other control operations.

3. Accessories fitted to the handlebars or the front fork area can create serious stability problems. This extra weight will cause the motorcycle to be less responsive to your steering control. The weight may also cause oscillations in the front end and lead to instability problems. Accessories added to the machine should be as light as possible and kept to a minimum.
4. The motorcycle may be affected by a lifting condition or by an instability in cross winds or when being passed or passing large vehicles. Improperly mounted or poorly designed accessories can result in an unsafe riding condition, therefore caution should be used when selecting and installing all accessories.
5. Certain accessories displace the rider from his or her normal riding position. This limits the freedom of movement of the rider and may limit his or her control ability.
6. Additional electrical accessories may damage the existing electrical system. Severe overloads may damage the wiring harness or create a dangerous situation due to the loss of electrical power during the operation of the motorcycle.

When carrying a load on the motorcycle, mount it as low as possible and as close as possible to the machine. An improperly mounted load can create a high center of gravity which is very dangerous and makes the motorcycle difficult to handle. The size of the “load” can also affect the aerodynamics and handling of the motorcycle.

Balance the load between the left and right side of the motorcycle and fasten it securely.



WARNING

Modification of the motorcycle, or removal of original equipment may render the vehicle unsafe or illegal.

TABLE OF CONTENTS

1. SERIAL NUMBER LOCATION	12
2. FUEL AND OIL RECOMMENDATION	12
FUEL	
ENGINE OIL	
TRANSMISSION OIL	
3. NAMES OF EACH PARTS	14
4. CONTROLS	17
IGNITION SWITCH	
IGNITION KEY	
INSTRUMENT PANEL	
OIL INDICATOR LAMP	
LEFT HANDLE SWITCH	
RIGHT HANDLE SWITCH	
5. HOW TO USE	21
HOW TO USE THE HELMET HOLDER	
HOW TO OPEN THE SEAT	
HOW TO USE THE PERSONAL TRUNK	
6. GASOLINE AND ENGINE OIL	23
HOW TO PROVIDE THE GASOLINE	
HOW TO SUPPLY THE ENGINE OIL	
7. THE PROPER OPERATIONS	25
STARTING THE ENGINE	
STARTING OFF	
OPERATING THE BRAKE	
STOPPING AND PARKING	

8. BREAK-IN	31
9. INSPECTION BEFORE RIDING	33
BRAKES	
TIRES	
INSPECTION OF FUEL	
INSPECTION OF ENGINE OIL	
INSPECTION OF LAMPS	
10. PERIODIC MAINTENANCE	40
EXHAUST PIPE AND MUFFLER	
FRONT FORK	
REAR SHOCK ABSORBER	
BRAKES	
TIRES	
AIR CLEANER	
BATTERY	
TRANSMISSION OIL	
ENGINE OIL AND GASOLINE	
FUSES	
SPARK PLUG	
REAR-VIEW MIRROR	
REFLECTOR	
RUBBER CAP OF CABLES	
TROUBLE SHOOTING	
WHEN KEEPING FOR LONG PERIOD	
CLEANING PROCEDURE	
11. LABEL	53
12. SPECIFICATIONS	54

SERIAL NUMBER LOCATION

The frame and/or engine serial numbers are used to register the motorcycle. They are also to assist your dealer in terms of ordering parts or referring to special service information.

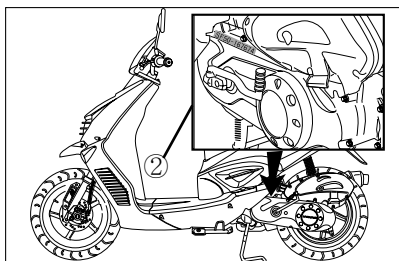
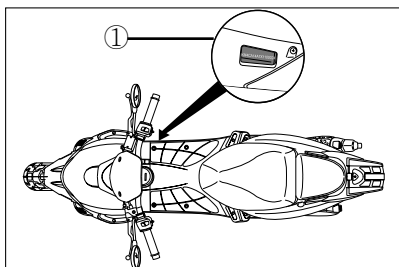

The frame serial number ① is stamped on the right side of frame under the footboard.

The engine serial number ② is stamped on the left upside of the crankcase assembly.

Please write down the numbers in the box provided below for your future reference.

Frame number :

Engine number :

FUEL AND OIL RECOMMENDATION

FUEL

Use unleaded gasoline with an octane rating of 91 or higher.

Unleaded gasoline can extend spark plug life and exhaust components life.

⚠ CAUTION

Spilling gasoline can damage the painted surfaces.

Be careful not to spill any fuel when filling the fuel tank.

Wipe spilled gasoline up immediately.

⚠ WARNING

- When refueling, always shut the engine off and turn the ignition key to the “⊗” (OFF) position. Never refuel near the flames, sparks and heat sources.
- Do not overfill the fuel tank. Do not fill the fuel tank above the entrance lower end.

ENGINE OIL

Use **HYOSUNG HYPOL OIL HS**.

If they are not available, use a good quality TWO-STROKE engine oil.

TRANSMISSION OIL

Use a good quality SAE 10W/30 or 10W/40 multi-grade oil.



WARNING

- Don't mix the unrecommended oil. It could damage the engine.
- When refilling the oil, don't allow the dust to get inside.
- Mop the oil spilt.
- Don't put the patch on the filler cap. It could disturb the oil to be provided and damage the engine.

NAMES OF EACH PARTS

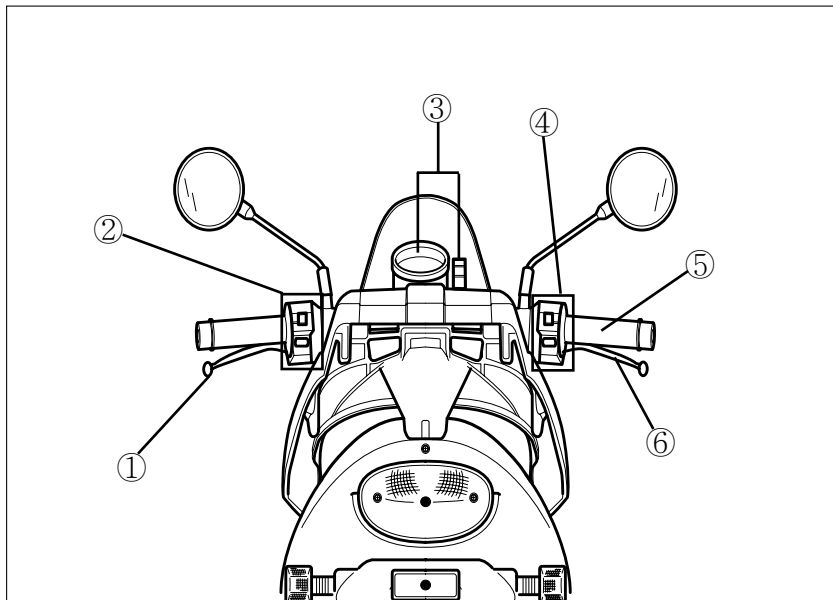

- ① Rear brake lever
- ② Left handle switches
- ③ Speedometer
- ④ Right handle switches
- ⑤ Throttle grip
- ⑥ Front brake lever

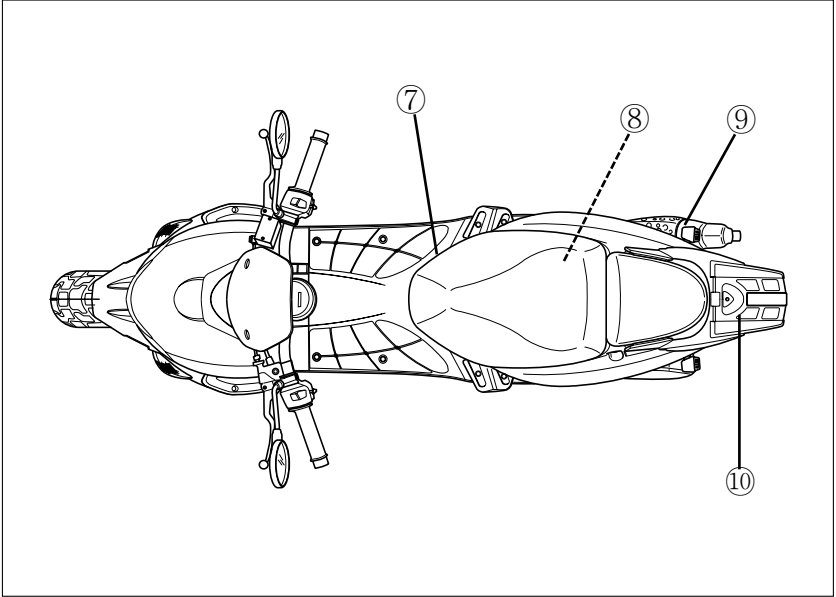

- ⑦ Fuel tank cover
- ⑧ Oil tank
- ⑨ Muffler
- ⑩ Rear carrier

NOTE

“-----” : means the invisible parts.

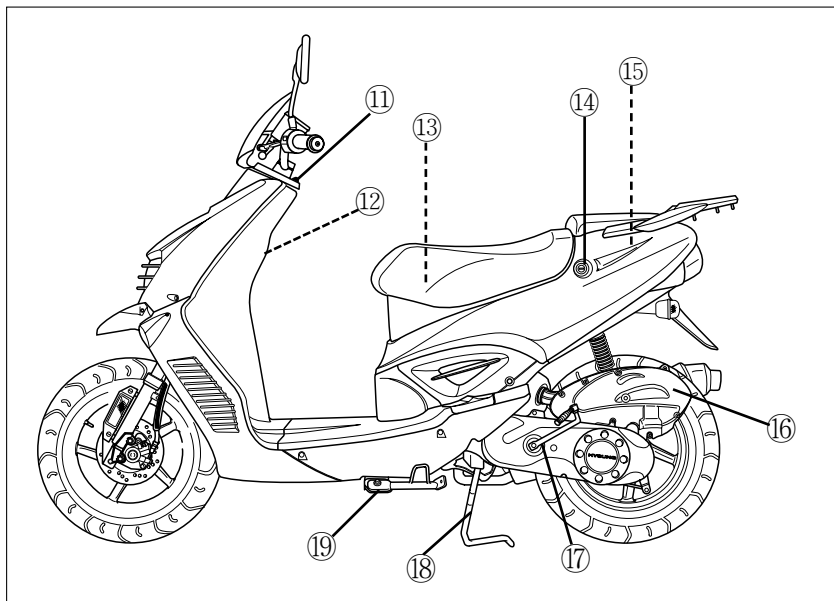

- ⑪ Oil indicator lamp
- ⑫ Ignition switches
- ⑬ Personal trunk
- ⑭ Seat lock
- ⑮ Battery & Fuse

- ⑯ Air cleaner
- ⑰ Kick starter lever
- ⑱ Center stand
- ⑲ Side stand

NOTE

“-----” : means the invisable parts.

CONTROLS

IGNITION SWITCH

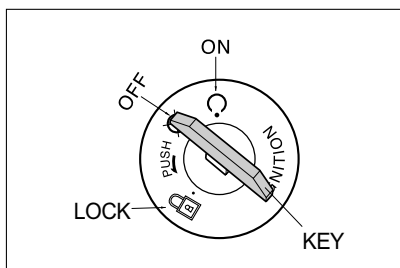

The ignition switch has three positions:

⊙ “⊗” (OFF) POSITION

All electrical circuits are cut off.

The engine will not start. The key can be removed.

⊙ “●” (ON) POSITION

The ignition circuit is completed and the engine can now start. The key cannot be removed from the ignition switch in this position.

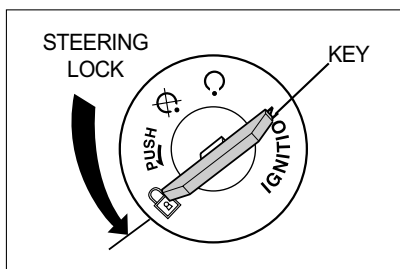

⊙ “🔒” (LOCK) POSITION

To lock the steering, turn the handlebar all the way to the left. Push down the key to the “⊗” (OFF) position and turn it to the “🔒” (LOCK) position and remove the key. All electrical circuits are disconnected.

⚠️ WARNING

Turning the ignition switch to the “⊗” (OFF) or “🔒” (LOCK) position while the motorcycle is moving can be hazardous. Moving the motorcycle while the steering is locked can be hazardous. You could lose your balance and fall, or you could drop the motorcycle.

Stop the motorcycle and place it on the side stand if equipped before locking the steering. Never attempt to move the motorcycle when the steering is locked.

IGNITION KEY

“*Ready*” comes equipped with a pair of identical ignition keys. Keep the spare key in a safe place.

Key number :

INSTRUMENT PANEL

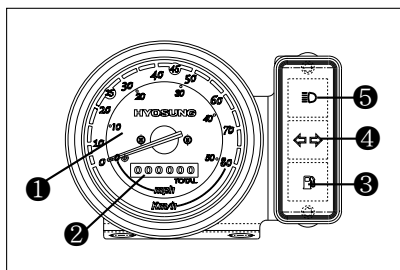

① SPEEDOMETER

The speedometer indicates the road speed in kilometers per hour and miles per hour.

② ODOMETER

The odometer registers the total distance that the motorcycle has been ridden.

③ FUEL INDICATOR LAMP

When the fuel drops below approximately 0.9 ℓ, the indicator lamp lit.

Fill the fuel tank before the indicator lamp lit.

The fuel tank capacity is 4.3 ℓ.

⚠ CAUTION

When the fuel indicator lamp comes on, you should add fuel to the fuel tank at the first opportunity to avoid running out of fuel.

⚠ CAUTION

For checking the fuel indicator lamp, hold the motorcycle vertically and the ignition switch "ⓘ" (ON).

④ TURN SIGNAL INDICATOR LAMP

When the turn signal are being operated either to the right or to the left, the indicator will flash at the same time.

⑤ HIGH BEAM INDICATOR LAMP

The high beam indicator lamp will come on when the head lamp high beam is turned on.

OIL INDICATOR LAMP

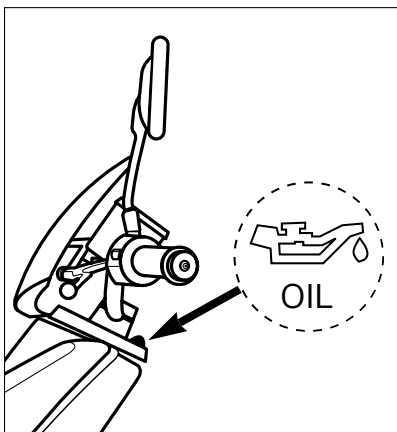

When the engine oil level in the tank becomes too low requiring "HYPOL OIL" refilling, the red indicator will light. When the oil indicator lamp turns on, the remaining amount of oil has become approximately 0.23 ℓ.

LEFT HANDLE SWITCH

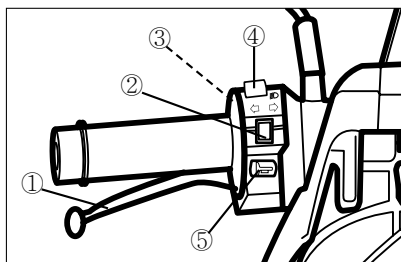

① REAR BRAKE LEVER

The rear brake is applied by squeezing the brake lever gently toward the handle grip.

Rear brake be anxious about motorcycle falling down when braking suddenly. The brake lamp will come on when the lever is squeezed.

WARNING

Apply the brake lightly and with great care on slippery surfaces to avoid skidding.

② TURN SIGNAL SWITCH

Using when left, right turn or change direction.

- “◁” Position : Flash the left turn signal lamp.
- “▷” Position : Flash the right turn signal lamp.

CAUTION

Always use the turn signals when you intend to change lanes or make a turn. Always be sure to turn the turn signal switch to the “OFF” position after completing the turn or lane change.

③ “PASS” SWITCH

Press the “PASS” switch to operate the head lamp high beam for using when pass.



With the ignition switch in the “ (ON) position, push the “PASS” switch to operate the head lamp high beam.

CAUTION

Do not operate when the dimmer switch “” position.

④ DIMMER SWITCH

Change the direction of head lamp light.

- “” : The head lamp high beam come on.
The high beam indicator lamp also comes on.
- “” : The head lamp low beam come on.

WARNING

Set the dimmer switch “” when other vehicle is running in front or against.

⑤ HORN SWITCH

Press the switch to operate the horn.

RIGHT HANDLE SWITCH

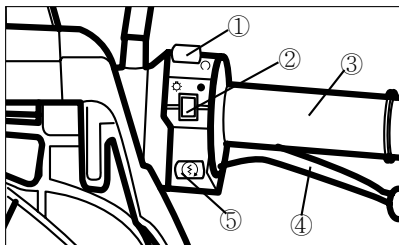

① ENGINE STOP SWITCH

- “☒” Position : Using when dangerous condition of falling down during drive and others or engine stop suddenly. The ignition circuit is off. The engine cannot start or run.
- “○” Position : Using when need operation of engine as drive and others. The ignition circuit is on and the engine can run.

⚠ WARNING

Do not operate for the engine stop switch is in the “☒” position while driving at one’s pleasure.

② LIGHT SWITCH

- “☀” : position
The head lamp, meter lamp and tail lamp come on.
- “●” : position
The head lamp, meter lamp and tail lamp go off.

③ THROTTLE GRIP

Engine speed is controlled by position of the throttle grip. Turn it toward you to increase engine speed. Turn it away from you to decrease the engine speed.

⚠ WARNING

Avoid turning the throttle grip during brakes.

④ FRONT BRAKE LEVER

The front brake is applied by squeezing the brake lever gently toward the throttle grip.

Front brake be anxious about motorcycle falling down when braking suddenly as disk brake system. The brake lamp will come on when the lever is squeezed.

⚠ WARNING

Apply the brake lightly and with great care on slippery surfaces to avoid skidding.

⑤ ⚙ STARTER SWITCH

Use this switch to operate the starting motor.

With the ignition switch in the “○” (ON) position, push the starter switch to start the engine.

N O T E

If the front or rear brake lever is not squeezed, the starting motor will not rotate.

⚠ CAUTION

Do not engage the starting motor for more than five seconds at a time as it may overheat the wiring harness and starting motor.

If the engine does not start after several attempts, check the fuel supply and ignition system.

(Refer for Page 51)

HOW TO USE

HOW TO USE THE HELMET HOLDER

When keep a helmet temporarily, use the helmet holder following the illustration below.

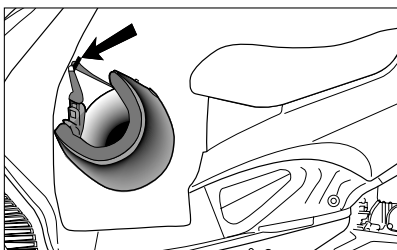

N O T E

Loading limit of helmet holder
: 1.5kg (3.3 lbs)

⚠ WARNING

Exceed loading limit may result in injury caused by damage to the vehicle or altered handling characteristics.

HOW TO OPEN THE SEAT

You can use the PERSONAL TRUNK after opening the seat.

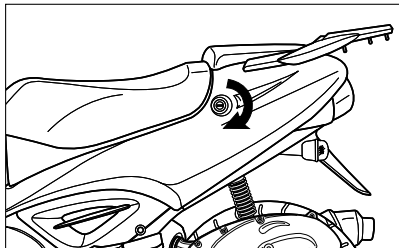

- 1) To unlock the seat, insert the ignition key into the lock and turn it clockwise.
- 2) To lock the seat, push down firmly until the seat latch snaps into the locked position.

HOW TO USE THE PERSONAL TRUNK

Keep the owner's manual or maintenance manual in the personal trunk. Put the helmet as shown in the picture.

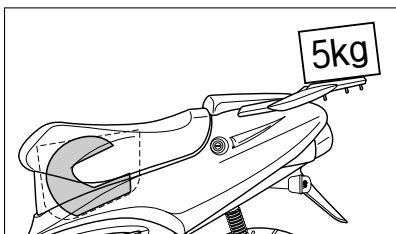

⚠ CAUTION

- The trunk could be heated. Don't keep anything that doesn't endure heat.
- Don't keep the fragile.
- Check if it is locked.
The unlocking of trunk could cause serious accident.
- Take care not to spill the oil in the trunk.
- Don't allow water to get inside the trunk or it could damage.
- Don't wash the trunk with water. Use the vacuum cleaner.
- Don't keep the valuables in the trunk when leaving unattended.
- Exceed loading limit may result in injury caused by damage to the vehicle or altered handling characteristics.

N O T E

- Loading limit of personal trunk : 10kg (22.1 lbs)
- Loading limit of rear carrier : 5kg (11.0 lbs)

GASOLINE AND ENGINE OIL

HOW TO PROVIDE THE GASOLINE

1. Insert the ignition key into the fuel tank cover lock located a rear of the right foot-board and turn it clockwise.
2. Open the fuel tank cover.
3. Turn the fuel tank cap counterclockwise.
4. Fill the fuel tank and turn the cap clockwise tightly.

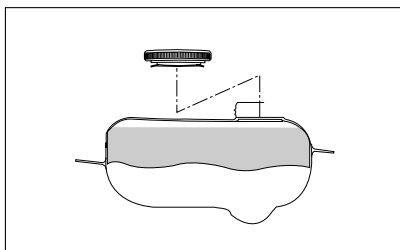
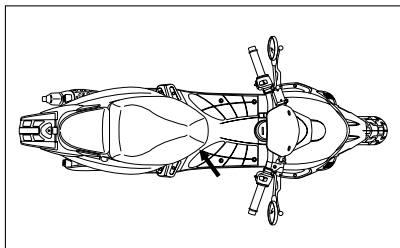

WARNING

- When refueling, always shut the engine off and turn the ignition key to the  (OFF) position. Never refuel near an open flame.
- Do not overfill the fuel tank. Stop adding fuel when the fuel level reaches the bottom of the filler neck. If you fill the tank beyond this level, fuel may overflow when it expands due to engine heat or heating by the sun.

WARNING

Gasoline is extremely flammable and toxic. Always observe the following precautions when refueling your *Revo*.

- Never permit motorcycle refueling by anyone other than an adult.
- Refuel in a well ventilated area.
- Make sure the engine is off and avoid spilling fuel on a hot engine.
- Do not smoke, and make sure there are no open flames or sparks in the area.
- Avoid prolonged contact with skin and breathing of gasoline vapors.
- Keep children and pets away during refueling.

HOW TO SUPPLY THE ENGINE OIL

1. Hold the motorcycle vertically with the center stand.
2. Open the seat and oil tank cap.
3. Fill the engine oil.
(Use the recommended oil)
4. Tighten the oil tank cap tightly.
5. Close the seat.
6. Confirm the seat lock.

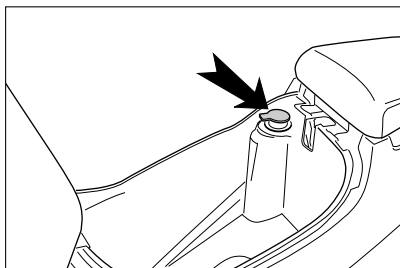

WARNING

Never operate the motorcycle without an adequate amount of oil, if the engine runs out of oil, it can stop suddenly, causing injury and/or severe mechanical damage.

CAUTION

- Don't mix the unrecommended oil. It could damage the engine.
- When refilling the oil tank, Don't allow the dust to get inside.
- Mop the oil spilt.
- Don't put the patch on the cap. It could disturb the oil to be provided and damage the engine.

WARNING

New and used oil and solvent can be hazardous. Children and pets may be harmed by swallowing new or used engine oil or solvent. Continuous contact with used engine oil has been found to cause skin cancer in laboratory animals. Brief contact with used oil or solvent may irritate skin.

- Keep new and used oil and solvent away from children and pets.
- Wear a long-sleeve shirt and waterproof gloves.
- Wash with soap if oil or solvent contact your skin.

THE PROPER OPERATIONS

STARTING THE ENGINE

Before riding

- Check how much the engine oil and gasoline is left.
- Put the motorcycle on the center stand.

⚠ CAUTION

Inspect every day once before riding the motorcycle.

- ① Set the ignition switch “” (ON).

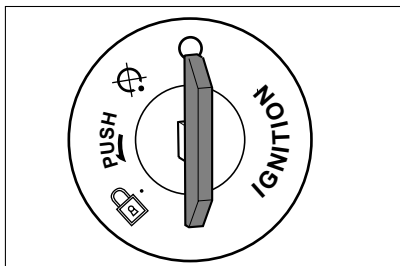

- ② Squeeze the rear brake lever.

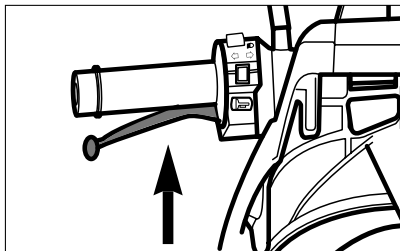

⚠ CAUTION

If the front or rear brake lever is not squeezed, the starting motor will not rotate.

- ③ Push the starter switch without turning the throttle grip.

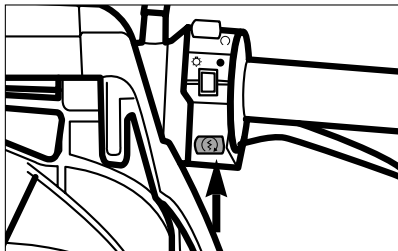

⚠ CAUTION

- Take off the starter switch right after started.
- Do not engage the starting motor for more than five seconds at a time as it may overheat the wiring harness and starting motor.

If the engine does not start after several attempts, check the fuel supply and ignition system.

(Refer for Page 51)

- When it doesn't start after several trial, turn the throttle grip to $\frac{1}{8}$ ~ $\frac{1}{4}$ position.

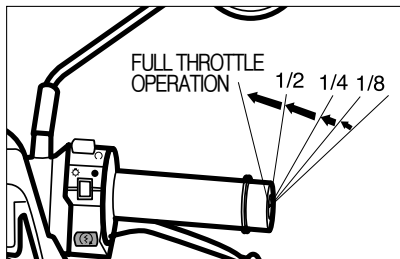

⚠ CAUTION

When started, return the throttle grip.

⚠ WARNING

Running the engine indoors or in a garage can be hazardous. Exhaust gas contains carbon monoxide, a gas that is colorless and odorless and can cause death or severe injury. Only run the engine outdoors where there is a fresh air.

⚠ CAUTION

Running the engine too long without riding may cause the engine to overheat. Overheating can result in damage to internal engine components and discoloration of exhaust pipes. Shut the engine off if you cannot begin your ride promptly.

- It is not started easily in the cases as follows.
 - 1) It has been long since you started the motorcycle.
 - 2) There was no gasoline left.
 In this case (1, 2), push the starter switch longer without turning the throttle grip.

- ④ When the engine is cold, idle it for a while.

⚠ WARNING

- Don't idle it indoor where there is little or no ventilation available.
- The exhaust gas including carbon monoxide is extremely poisonous.

- ⊙ Start using by the kick starter lever

You can start using by the kick starter lever when there is some problem in battery.

- ① Put the motorcycle on the center stand.
- ② Set the ignition switch "⊙" (ON).
- ③ Press forcefully the kick starter lever.

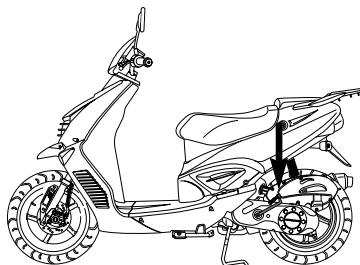

⚠ CAUTION

When started, return the kick starter lever.

STARTING OFF

1 Return the center stand.

For returning the center stand, push the motorcycle forward gripping the rear brake lever with left hand and the rear carrier with right hand.

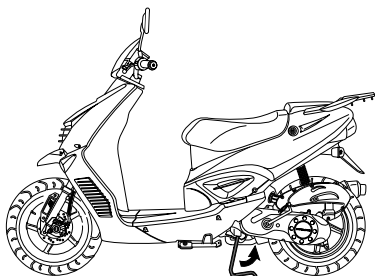

⚠ CAUTION

When returning the center stand, grip the rear carrier.

2 Ride on

Gripping the lever with both hands, be seated on from leftside of the motorcycle. Put the left foot on the earth and fasten the rear brake lever.

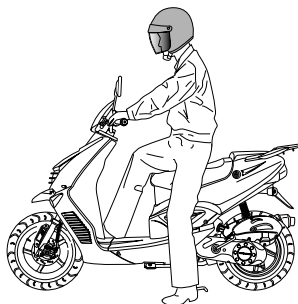

⚠ CAUTION

Don't let the engine run excessively before riding.

2 Check the safety

Turn on the left turn signal lamp and check the safety. Grip up the rear brake lever.

⚠ WARNING

Be careful of the vehicles in back.

4 Start off

Take off the rear brake lever and turn the throttle grip slowly, the motorcycle will start moving forward.

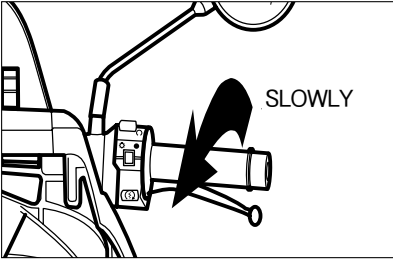

WARNING

Sudden side winds, which can occur when being passed by large vehicles, at tunnel exits or in hilly areas, can upset your control.

Reduce your speed and be alert to side winds.



WARNING

When turned the throttle grip excessively, it will make quick start which is dangerous.



WARNING

Riding this motorcycle at excessive speed increases your chances of losing control of the motorcycle.

This may result in an accident.

Always ride within the limits of your skills, your motorcycle, and the riding conditions.



WARNING

Do not operate the ignition switch of its "⊗" (OFF) or "🔒" (LOCK) position or the engine stop switch of its "⊗" position while driving at one's pleasure.



WARNING

Removing your hands from the handlebars or feet from the footrests during operation can be hazardous. If you remove even one hand or foot from the motorcycle, you can reduce your ability to control the motorcycle.

Always keep both hands on the handlebars and both feet on the footrests of your motorcycle during operation.

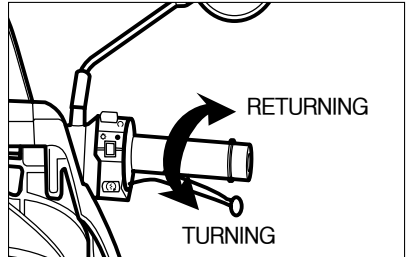

You can adjust the speeds with the throttle grip.

Turning --- Get faster

Returning --- Get slower

OPERATING THE BRAKE

Apply the front and rear brakes at the same time.

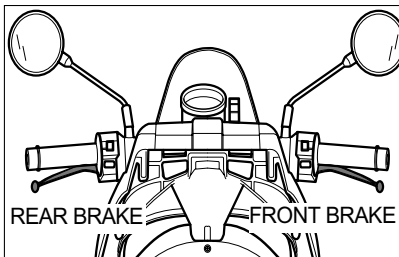

- Grip the brake lever right after returning the throttle grip.
- Make the speed lower by operating the brake slowly.



WARNING

Using either front or rear brake is dangerous and can cause skidding and loss of control.

⊙ Pay much more attention to driving when rains or snows.

- When the brake doesn't work normally, keep low speeds and apply the brake lightly until smoothly operated.



⊙ The quick brake can cause skidding.

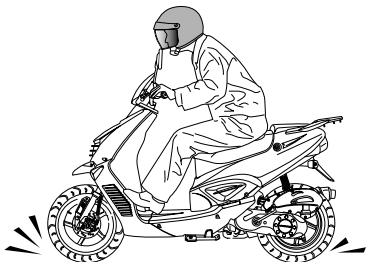

STOPPING AND PARKING

- 1 Turn on the turn signal lamp and return the throttle grip.
- 2 When completely stopped, turn off the turn signal lamp. Set the key “” (OFF) position.

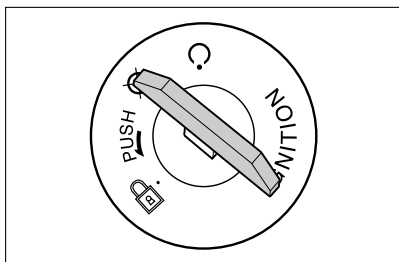

- 3 Put the motorcycle on the center stand.

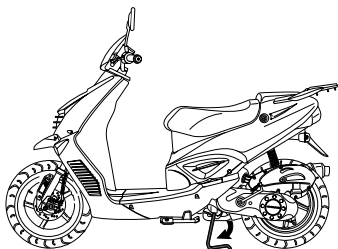

CAUTION

Don't park the motorcycle on the slippery or tilted surface.

WARNING

Hard braking while turning may cause wheel skid and loss of control.

Brake before you begin to turn.

WARNING

Hard braking on wet, loose, rough, or other slippery surfaces can cause wheel skid and loss of control.

Brake lightly and carefully on slippery or irregular surfaces.

WARNING

Following another vehicle too closely can lead to a collision. As vehicle speeds increase, stopping distance increases progressively.

Be sure you have a safe stopping distance between you and the vehicle in front of you.

- 4 Lock the steering for security.
- 5 Pull the ignition key out of the lock and keep it yourself.

WARNING

A hot muffler can burn you. The muffler will be hot enough to burn you for some time after stopping the engine.

Park the motorcycle where pedestrians or children are not likely to touch the muffler.

BREAK-IN

The opening explains how important proper break-in is to achieve maximum life and performance from your new **Hyosung**. The following guidelines explain proper break-in procedures.

★ MAXIMUM THROTTLE OPENING RECOMMENDATIONS

The table below shows the maximum throttle opening recommendation during the break-in period.

Initial 800km (500miles)	Less than 1/2 throttle
Up to 1,600km (1,000miles)	Less than 3/4 throttle

★ AVOID CONSTANT LOW SPEED

Operating the engine at constant low speed(light load) can cause parts to glaze and not seat in. Allow the engine to accelerate freely through the gears, without exceeding the recommended maximum limits. Do not, however, use full throttle for the first 1,600km(1,000 miles).

★ VARY THE ENGINE SPEED

The engine speed should be varied and not held at a constant speed.

This allows the parts to be "loaded" with pressure and then unloaded, allowing the parts to cool.

This aids the mating process of the parts.

It is essential that some stress be placed on the engine components during break-in to ensure this mating process.

Do not, though, apply excessive load on the engine.

★ BREAKING IN THE NEW TIRES

New tires need proper break-in to assure maximum performance, just as the engine does.

Wear in the tread surface by gradually increasing your cornering lean angles over the first 160km(100miles) before attempting maximum performance. Avoid hard acceleration, hard cornering, and hard braking for the first 160km(100miles).



WARNING

Failure to perform break-in of the tires could cause tire slip and loss of control. Use extra care when riding on new tire. Perform proper break-in of the tire as described in this section and avoid hard acceleration, hard cornering, and hard braking for the first 160km(100miles).

★ ALLOW THE ENGINE OIL TO CIRCULATE BEFORE RIDING

Allow sufficient idling time after warm or cold engine start up before applying load or revving the engine. This allows time for the lubricating oil to reach all critical engine components.

★ OBSERVE YOUR FIRST, AND MOST 1,000km SERVICE

The 1,000km (600miles) service is the most important service your motorcycle will receive.

During break-in procedures, all of the engine components will have worn in and all of the other parts will have seated in.

All adjustments will be restored, all fasteners will be tightened, and the dirty engine oil will be replaced.

Timely performance of the 1,000km (600miles) service will ensure optimum service life and performance from the engine.

 CAUTION

Service should may be performed before 1,000km(600miles) on motorcycle that are used under severe conditions.

 CAUTION

The 1,000km (600miles) service should be performed as outlined in the PERIODIC MAINTENANCE section of this Owner's Manual. Pay particular attention to the 『CAUTION』 and 『WARNING』 in that section.

INSPECTION BEFORE RIDING

Before riding the motorcycle, be sure to check the following item.

Inspect every day once them before riding motorcycle.

WHAT TO CHECK	CHECK FOR :
Steering	<ul style="list-style-type: none"> ● Smoothness ● No restriction of movement ● No play or looseness
Throttle	<ul style="list-style-type: none"> ● Correct play in the throttle cable ● Smooth operation and positive return of the throttle grip to the closed position
Brakes	<ul style="list-style-type: none"> ● Fluid level in the reservoir to be above "LOWER" line ● Correct lever play ● No "sponginess" ● No fluid leakage ● Brake pads or shoes not to be worn down to the limit line
Suspension	Smooth movement
Fuel	Enough fuel for the planned distance of operation
Tires	<ul style="list-style-type: none"> ● Correct pressure ● Adequate tread depth ● No cracks or cuts
Engine oil	Correct level and pollution degree of engine oil
Lighting	Operation of all lights and indicators
Horn	Correct function
Engine stop switch	Correct function

⚠ CAUTION

- The engine and muffler are too hot right after engine stopped, please be careful not to be burned.
- Don't inspect the engine indoor where there is little or no ventilation available. The exhaust gas is extremely poisonous.

BRAKES

"*Ready*" utilizes disk brake for front, and drum brake for rear.

Properly operating the brake systems are vital to safe riding. Be sure to perform the brake inspection requirements as schedules.

The brakes should be inspected at periodic inspection by your authorized Hyosung dealer.

⦿ BRAKE LEVER

- Turn the front/rear brake adjuster clockwise/or counterclockwise to obtain the specified play.
- After adjusting the play, check there is no dragging and enough clearance between the brake lever and grip when the lever is tightly squeezed.

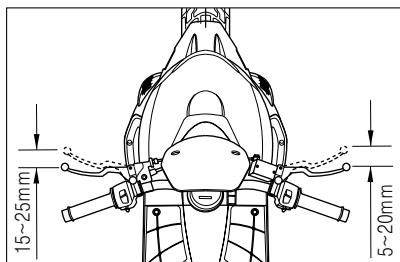

WARNING

Too much play in the front or rear brake lever can cause poor braking performance and may lead to an accident.

Too little play may force brake pads (or shoes) to rub against the disk(or drum) at all times, causing damage to the pads and disk(or shoes and drum).

WARNING

Failure to properly inspect and maintain your motorcycle brake systems can be hazardous.

Improper maintenance of the brakes increases your chances of having an accident.

Be sure to inspect the brakes before each use of the motorcycle according to the **INSPECTION BEFORE RIDING** section. Always maintain your brakes according to the **MAINTENANCE SCHEDULE**.

WARNING

Operating the motorcycle in harsh condition can be hazardous if you do not inspect brake wear often.

Operating in mud, water, sand, or other extreme conditions can cause accelerated brake wear. This could lead to an accident.

If you operate your motorcycle under these conditions, the brakes must be inspected more often than recommended in the **MAINTENANCE SCHEDULE**.

BRAKE FLUID

Be sure to check the brake fluid level in the master cylinder. If the level was found to be lower than the lower mark while holding the motorcycle upright, replenish with the proper brake fluid that meets Hyosung's requirements.

As the brake pads wear, the fluid level will drop to compensate for the new position of brake pads.

Replenishing the master cylinder to considered normal periodic maintenance.

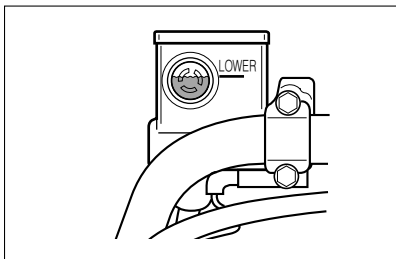



WARNING

Brake fluid may be harmful if swallowed or if it comes in contact with skin or eyes. Contact your doctor immediately if brake fluid is swallowed and induce vomiting. If brake fluid gets into the eyes or in contact with the skin, flush thoroughly with plenty of water.



CAUTION

This motorcycle uses glycol-based brake fluid. Do not use or mix different types of brake fluid, otherwise serious damage will result in the brake system.

Use DOT4 brake fluid. Do not spill any brake fluid on painted or plastic surfaces as it will damage the surface severely.

Never use any brake fluid that has been stored in a used or unsealed container. Never reuse brake fluid left over from the last servicing and stored for long period as it absorbs moisture from the air.

⊙ BRAKE PADS AND SHOES

Inspect the front brake pads and rear brake shoes by nothing whether or not the friction pads(shoes) are worn down to the limit line. If a pad(shoe) is worn to the limit line it must be replaced with a new one by your authorized Hyosung dealer or qualified service mechanic.

Inspect every day in the following point at the brake system.

- ① Brake fluid leakage of the front brake system.
- ② Leak or damage of the brake hose or cable.
- ③ Operating of the brake lever.
- ④ Wear of the front brake pads and rear brake shoes.



CAUTION

The front brake system be replaced the brake hose or the brake fluid according to periodic inspection chart by your authorized Hyosung dealer for safety as in times of operating at high pressure.



WARNING

Riding with worn brake pads or shoes will reduce braking performance and will increase your chance of having accident. Inspect brake pad or shoe wear before each use. Ask your Hyosung dealer or qualified mechanic to replace brake pads(shoes) if any pad(shoe) is worn to the limit.



CAUTION

After replaced the front brake pads or rear brake shoes, the brake lever pull and release several times so that it is setting at the original place.

Then, do not ride the motorcycle until operating the brake fluid and becoming the brake distance.

⊙ BRAKE DISK INSPECTION

Check the brake disk for damage or cracks.

TIRES

Inspect the tire pressure and the tire thread depth periodically.

Inspect frequently the tire pressure for the safety and the tire life.



WARNING

Failure to follow these warnings may result in an accident due to tire failure. The tires on your motorcycle form the crucial link between your motorcycle and the road.

Follow these instructions ;

- **Check tire condition and pressure, and adjust pressure before each ride.**
- **Avoid overloading your motorcycle.**
- **Replace a tire when worn to the specified limit, or if you find damage such as cuts or cracks.**
- **Always use the size and type of tires specified in this owner's manual.**

⊙ TIRE PRESSURE

Insufficient air pressure in the tires not only hasten tire wear but also seriously affects the stability of the motorcycle.

Under-inflated tires make smooth cornering difficult and over-inflated tires decrease the amount of tire in contact with the ground which can lead to skids and loss of control. Be sure that the tire pressure is within the specified limits at all times.

Tire pressure should only be adjusted when the tire is cold.

If you see the problem with the tire, adjust the pressure with the pressure gauge.

TIRE PRESSURE (COLD INFLATION)	NORMAL RIDING	
	SOLO RIDING	DUAL RIDING
FRONT	1.25 kg/cm ² 123 kpa 18.0 psi	1.75 kg/cm ² 172 kpa 25.0 psi
REAR	2.00 kg/cm ² 196 kpa 29.0 psi	2.25 kg/cm ² 221 kpa 33.0 psi

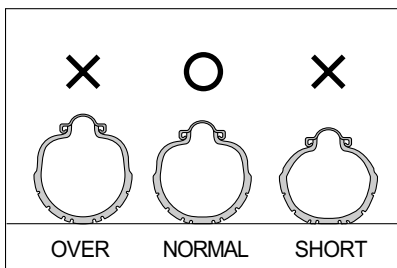

CAUTION

If there are some problem with the tire pressure or cracks and cuts, it will decrease the riding stability and lead to flat tire.

⊙ CRACKS AND CUTS

Check if

- 1) there are visible cracks and cuts.
- 2) there are pebbles stuck.

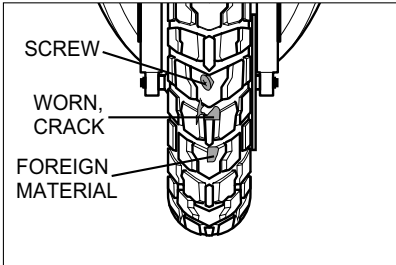

⊙ TIRE TREAD CONDITION

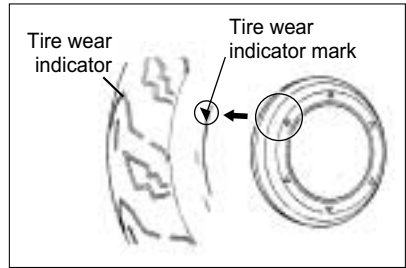

Operating the motorcycle with excessively worn tire will decrease riding stability and can lead to loss of control.

Inspect storage of tire thread's depth by the 'tire wear indicator'.

Replace the front and rear tires at once when appear the 'tire wear indicator'.

⚠ CAUTION

The standard tire on 'Revo' is 120/90- 10 66J for front, and 130/90- 10 70J for rear.

The use of a tire other than standard may cause trouble.

It is highly recommended to use the standard tire supplied by Hyosung.

INSPECTION OF FUEL

Check if the remaining gasoline is enough for running to the destination.

Replenish the GASOLINE when the Fuel indicator lamp on with the ignition switch in the "O" (ON).

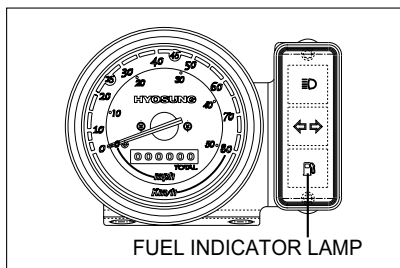

⚠ CAUTION

The lack of fuel will go off suddenly.
Failure to observe this precaution may result in loss of control and an accident.

INSPECTION OF ENGINE OIL

Replenish the ENGINE OIL when the Oil indicator lamp on with the ignition switch in the "O" (ON).

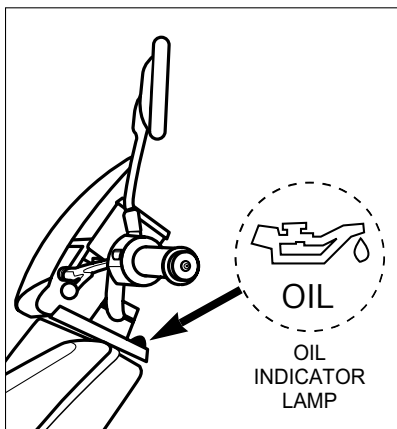

⚠ CAUTION

The lack of engine oil will damage engine severely.

INSPECTION OF LAMPS

- Check if the head lamp, tail lamp and turn signal lamp work well with engine started.
- Check if the head lamp are dusty or damaged.

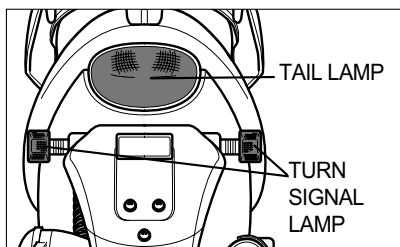
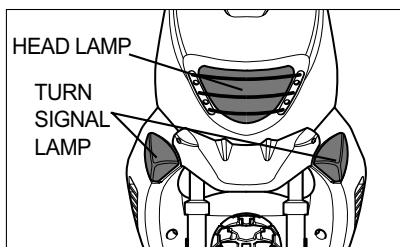

⊙ REPLACEMENT OF THE LAMP

Requirement electric power of the lamp shown in the following chart.

When replace the damaged lamp, always use the equal capacity.

The use of a lamp other than rules may cause to excessive at the electric system or to damage the lamp.

NAMES		CAPACITY
Head lamp	HI	35W×1
	LO	35W×1
Brake / Tail lamp		21/5W
Turn signal lamp		21W×2 + 10W×2

⚠ CAUTION

The use of a lamp other than rules may cause to occur the vehicle fire and to damage electric parts.

Surely use only the lamp of proper capacity.

PERIODIC MAINTENANCE

The chart indicates the intervals between periodic service in kilometers.

At the end of each interval, be sure to inspect, check, lubricate and service as instructed.

If your motorcycle is used under high stress conditions such as continuous full throttle operation, or is operated in a dusty climate, certain services should be performed more often to ensure reliability of the machine as explained in the maintenance section.

Your **Hyosung** dealer can provide you with further guide lines.

Steering components, suspensions and require very special and careful servicing. For maximum safety we suggest that you have these items inspected and serviced by your authorized **Hyosung** dealer or a qualified service mechanic.

⊕ LUBRICATION POINTS

Proper lubrication is important for smooth and long life of each working part of your motorcycle and also for safe riding. It is a good practice to lubricate the motorcycle after a long rough ride or after it gets wet in the rain or after washing it.

Major lubrication points are indicated as follows.



WARNING

Improper maintenance or failure to perform recommended maintenance increases the chance of an accident or motorcycle damage.



CAUTION

**Using poor quality replacement parts can cause your motorcycle to wear more quickly and may shorten its useful life.
Use only genuine Hyosung replacement parts or their equivalent.**

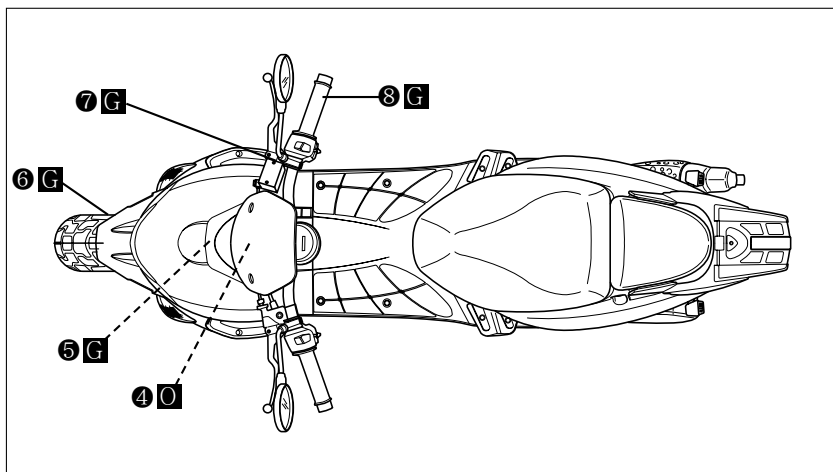
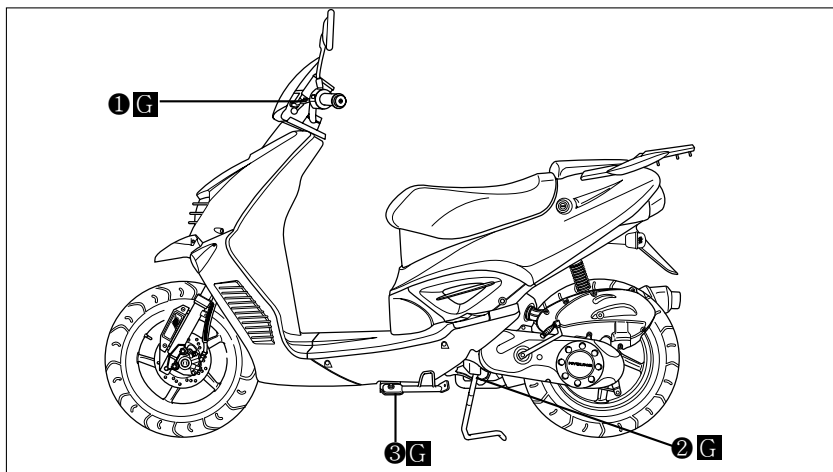

- ① Rear brake lever holder
- ② Center stand pivot and spring hook
- ③ Side stand pivot and spring hook
- ④ Throttle cable
- ⑤ Steering stem bearing

- ⑥ Speedometer gear box
- ⑦ Front brake lever holder
- ⑧ Throttle grip

○ - Motor oil G - Grease

※ “----”: means the invisible parts.

⊙ ENGINE

Item \ Interval	First 1,000 km	Every 4,000 km	Every 8,000 km
Air cleaner element	Clean every 3,000 km · Replace every 12,000 km		
Exhaust pipe nuts and muffler mounting bolts ★	Tighten	Tighten	—
Cylinder head nuts ★	Tighten	Tighten	—
Cylinder head & Cylinder ★	—	—	Remove carbon
Spark plug	Clean	Clean	Replace
Fuel hose	Inspect	Inspect	—
	Replace every 4 years		
Throttle cable	Inspect	Inspect	—
Idle speed ★	Inspect	Inspect	—
Oil pump ★	—	Inspect	—
Transmission oil ★	Inspect	—	Inspect

⊙ CHASSIS

Item \ Interval	First 1,000 km	Every 4,000 km	Every 8,000 km
Drive belt ★	—	—	Inspect
Brake ★	Inspect	Inspect	—
Brake hose ★	Inspect	Inspect	—
	Replace every 4 years		
Brake fluid ★	Inspect	Inspect	—
	Replace every 2 years		
Tire	Inspect	Inspect	—
Steering ★	Inspect	Inspect	—
Front forks ★	—	Inspect	—
Rear shock absorber ★	—	Inspect	—
Chassis nuts and bolts ★	Tighten	Tighten	—

N O T E

★ = Ask your Hyosung dealer or qualified mechanic to do the maintenance items marked.

EXHAUST PIPE AND MUFFLER

Inspect the exhaust pipe and muffler joint for loosening.

FRONT FORK

- Check if there is any noise by bend of front fork while moving the handle upward and downward.
- Inspect whether the steering stem is well assembled while moving front fork up/downwards and/or forward/backward.

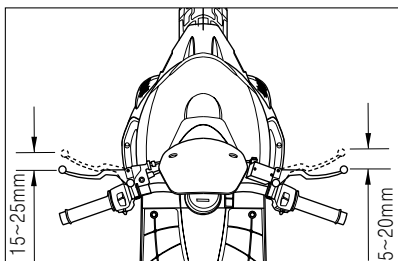
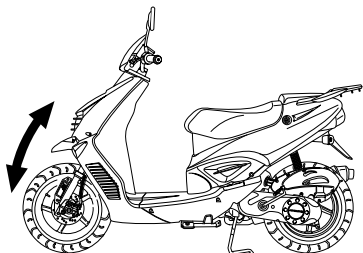

- Check the front/rear brake while running in low speeds.
- Check if there is leakage or damage on the brake fluid reservoir and the connected parts are loose.
- Check if the vibration damages the brake hose while moving the handle left/right or running.

REAR SHOCK ABSORBER

Inspect the rear shock absorber for oil leakage and spring condition.

BRAKES

- Turn the front/rear brake adjuster clockwise or counterclockwise to obtain the specified play.

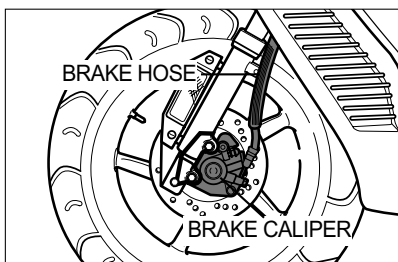

⊙ BRAKE FLUID

- Keep the motorcycle upright and place the handle straight.
- Check the brake fluid level by observing the “LOWER” line.
- When the level is below the “LOWER” line, check if there is leakage.
- How to replenish with brake fluid
 1. Keep the motorcycle upright and place the handle straight.
 2. Clean the brake fluid reservoir around

- not to allow dusts to get inside of it.
- Loosen the screw and open the cap.
 - Replenish with brake fluid to the limit line.

NOTE

The recommended brake fluid : DOT 4

- Fasten the cap.

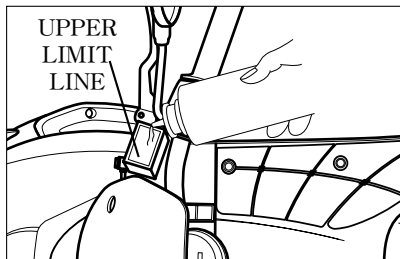

CAUTION

- Don't replenish with brake fluid over the limit line. It will leak out of the brake fluid reservoir.
- Be careful not to allow dusts or water to go inside when it is replenished.
- Don't use the unrecommended brake fluid.
- Brake fluid can damage severely the plastics or rubbers. When it is spilt on the parts, mop them up.

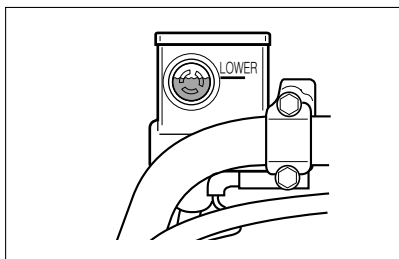

⊙ BRAKE PADS

- Wearing condition of brake pads can be checked by observing the wear limit line on the pads. When the wear exceeds the limit line, replace the pads.

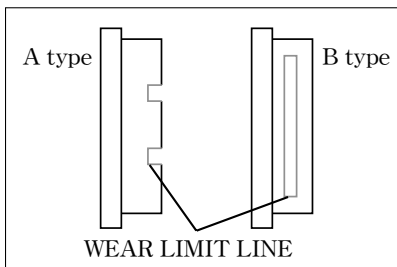

⊙ BRAKE SHOE

Ray is equipped with the brake shoe wear limit indicators on the rear brakes.

To check wear of the brake shoe, perform the following :

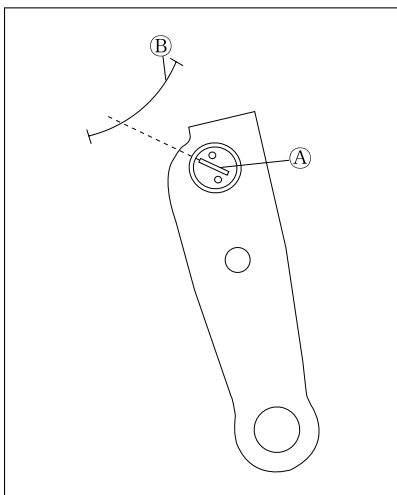

- ① While fully applying the brake, check to see that the extension line of the rear brake cam lever groove (A) is within the index mark (B) on the crankcase.
- ② If the extension line is beyond the index mark, have the brake shoe assembly replaced by your Hyosung dealer to ensure safe operation.

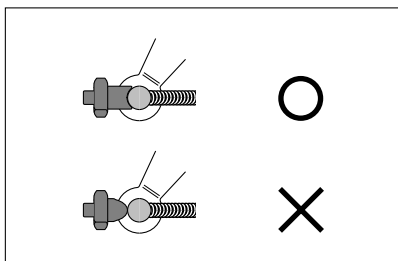

⊙ ADJUSTMENT OF REAR BRAKE LEVER PLAY

Adjust the lever play to 15~25mm (0.59~0.98in) by screwing in or out the adjusting nut ① of brake cam lever.

After adjustment, check if it is within the required range when you squeeze the brake lever until feel the resistance.

PLAY OF REAR BRAKE LEVER	
Standard	15~25mm (0.59~0.98in)

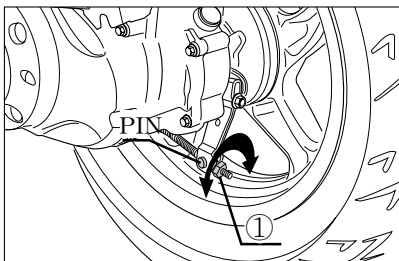

⚠ CAUTION

- When it is beyond the index mark, replace the brake shoe.
- Fix  part of nut to pin or serious accident can be cause by the brake failure.

TIRES

Check the tire pressure when it is cold.

TIRE PRESSURE (COLD INFLATION)	NORMAL RIDING	
	SOLO RIDING	DUAL RIDING
FRONT	1.25 kg/cm ² 123 kpa 18.0 psi	1.75 kg/cm ² 172 kpa 25.0 psi
REAR	2.00 kg/cm ² 196 kpa 29.0 psi	2.25 kg/cm ² 221 kpa 33.0 psi

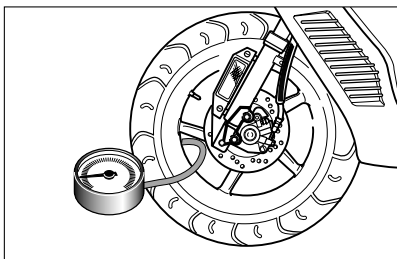

AIR CLEANER

If the air cleaner element has become clogged with dust, intake resistance will increase with a resultant decrease in power output and an increase in fuel consumption. If riding under severe conditions must be cleaned or replaced more frequently than maintenance schedule. Check and clean the air cleaner element periodically according to the following procedure.

⚠ CAUTION

If the air cleaner element is polluted, will occur to starting go out, output insufficiency, combustion efficiency decline, and sooty smoke(black smoke). This appearance is occurred at first to clean the air cleaner element and confirm.

1. Take out the air cleaner cap by disassembling 7 screws.
2. Take off the air cleaner element.

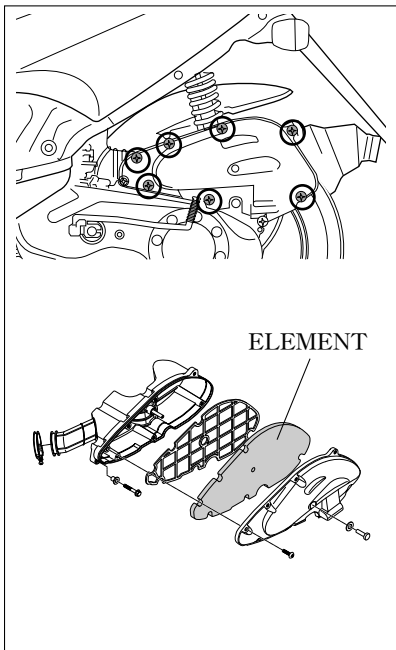

3. Fill a washing pan of a proper size with nonflammable cleaning solvent (A). Immerse the element in the cleaning solvent and wash it clean.
4. Squeeze the cleaning solvent out of the washed element by pressing it between the palms of both hands : do not twist or wring the element or it will develop tears.
5. Immerse the element in HYOSUNG genuine oil (B) and squeeze the oil out of the element leaving it slightly wet with oil.
6. Assemble the air cleaner element.

⚠ CAUTION

Before and during the cleaning operation, inspect the element for tears. A torn element must be replaced.

Be sure position the element snugly and correctly, so that no incoming air will bypass it.

Remember, rapid wear of piston rings and cylinder bore is often caused by a defective or poorly fitted element.

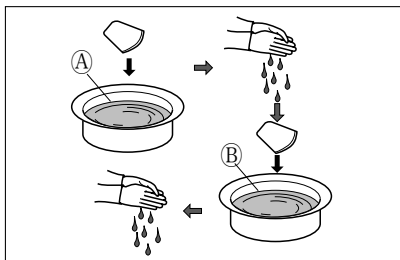

⚠ CAUTION

- Don't use the cleaning solvent whose flash point is low when cleaning the element.
- Assemble the element completely or damage severely the engine.
- Be careful not to allow water to go inside the air cleaner element.

⚠ CAUTION

- When the assembly of air cleaner element is not completely done, dusts can go inside and damage severely engine.
- Be careful not to allow water to go into the element while washing.

⚠ CAUTION

More frequent servicing may be performed on motorcycles that are used under severe conditions, also clean the air cleaner element to prevent damage of the engine.

BATTERY

Ⓞ INSPECTION OF BATTERY SOLUTION LEVEL

MF(Maintenance Free) battery of airtight type is used for this motorcycle.

It is not necessary to inspect or supplement battery fluid.

The battery is located under the pillion seat.

However, have your dealer check the charging condition of battery periodically.

⚠ CAUTION

- Do not remove absolutely airtight cover as airtight type battery.
- Keep after separate at the motorcycle for the minimum of self electric discharge and electric leakage when don't use for a long time.
Remove the (–) negative terminal when keep intact at the motorcycle.

⊙ CLEAN OF BATTERY TERMINAL

Clean the battery terminal when it is dusty or rusted.

1. Set the ignition switch “” (OFF) position.
2. Disassemble the pillion seat, disassemble the (+) positive battery wire after the (-) negative battery wire.
Remove the battery.
3. Clean the terminal.
If there is white dust, clean it with warm water.
4. Assemble the battery wires and grease the terminal lightly.

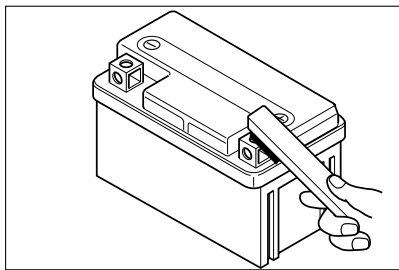

CAUTION

- Keep the battery away from fires.
- When disassemble the battery wire, take off \ominus terminal first with the ignition switch “” (OFF) position. When assemble, \oplus terminal first.
- Fasten certainly the battery wires.
- Incorrect installation of the battery will reverse the terminal position resulting in possible electrical system damage due to incorrect battery lead connection.
- Never charge a battery while still in the machine as damage may result to the battery or regulator/rectifier.

TRANSMISSION OIL

Check if the transmission oil leaks.

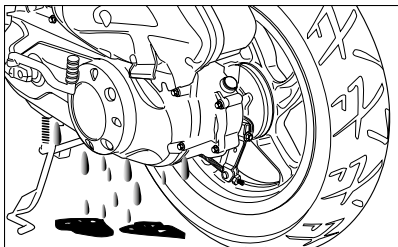

ENGINE OIL AND GASOLINE

- Check if there is leakage around the oil pump and oil tank.

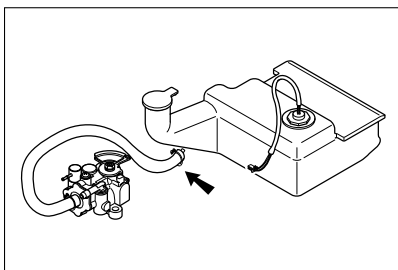

- Check if there is leakage from fuel tank, fuel pump, hose and carburetor.

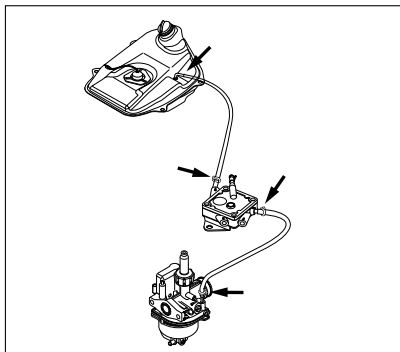

FUSES

The fuse holder is located under the pillion seat.

If the engine suddenly stops while running or any electrical system fails to operate then the fuse must be checked.

In case a fuse blows there is a 10A spare fuse.

Check the fuse with the ignition switch \otimes (OFF).

1. Remove the battery cover under the pillion seat.
2. Take out the fuse holder.
3. Open the fuse holder and take out the fuse.

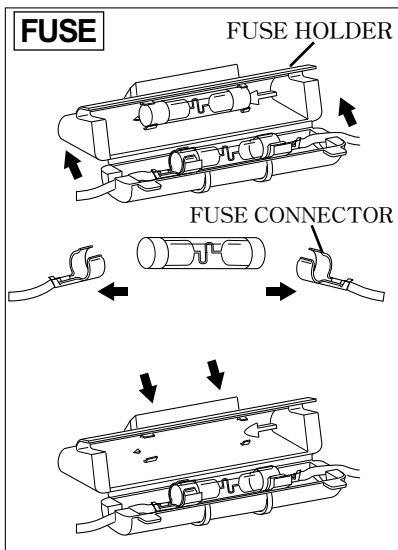

⚠ CAUTION

Never use other than specified 10A fuse. Installing a fuse of incorrect rating may seriously damage the electrical system. You should consult your Hyosung dealer or a qualified service mechanic immediately.

SPARK PLUG

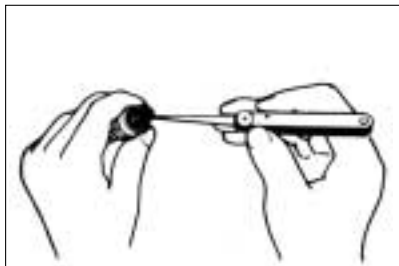

Remove the carbon deposits periodically from the spark plug with a piece of hard wire or pin.

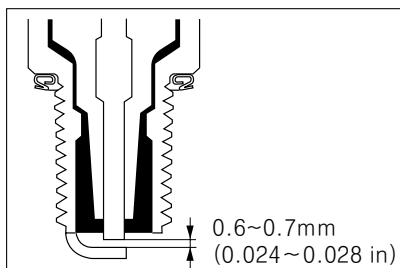

Readjust the spark plug gap to 0.6~0.7mm (0.024 ~ 0.028 in) by using a spark plug gap thickness gauge.

PLUG REPLACEMENT GUIDE

Hotter type	BR7HSA
Standard type	BR8HSA
Colder type	BR9HSA

⚠ CAUTION

- Do not over torque or cross thread the spark plug or the aluminum threads of the cylinder head will be damaged.
Do not allow contaminants to enter the engine through the spark plug holes when the plug is removed.
- The standard spark plug for this motorcycle has been carefully selected to meet the vast majority of all operational ranges. If the spark plug color indicates that other than a standard spark plug be used, it is best to consult your **Hyosung** dealer before selecting an alternate plug or heat range. The selection of an improper spark plug can lead to severe engine damage.

REAR-VIEW MIRROR

Check if the mirror shows the rear and/or side views.

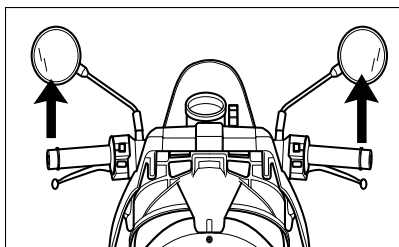

REFLECTOR

- Check if the reflector is dusty or damaged.

RUBBER CAP OF CABLES

Mop them up with a patch when washing.

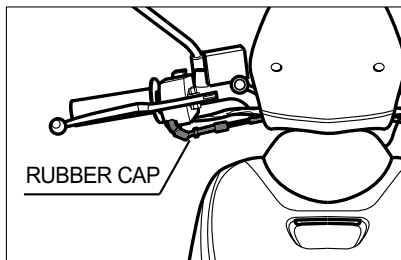

TROUBLE SHOOTING

⊕ WHEN THE ENGINE REFUSES TO START

If the engine refuses to start, perform the following inspections to determine the cause.

● Fuel Supply Check

- ① Is there enough fuel in the fuel tank?
- ② Is the fuel reaching the carburetor from the fuel pump?
- ③ If it has been determined that fuel is reaching the carburetor, the ignition system should be checked next.

● Ignition System Check

- ① Remove a spark plug and reattach to the spark lead.
- ② While holding the spark plug firmly against the engine, crank the engine with the ignition switch in the "⊙" (ON) switch.

If the ignition system is operating properly, a blue spark should jump across the spark plug gap.

- ③ If there is no spark, clean the spark plug. Replace it if necessary. Retry the above procedure with the cleaned spark plug or new one.
- ④ If there is still no spark, consult your Hyosung dealer for repairs.

⚠ WARNING

Performing the spark test improperly can cause a high voltage electrical shock or an explosion.

Avoid performing this check if you are not familiar with this procedure, or if you have a heart condition or wear a pacemaker. Keep the spark plug away from the spark plug hole during this test.

⚠ WARNING

Do not hold the spark plug close to the open spark plug hole in the cylinder head as gasoline vapor inside the cylinder should be ignited, creating a fire hazard.

● Engine Stalling

- ① Check the fuel supply in the fuel tank.
- ② Check the ignition system for intermittent spark.
- ③ Check the engine idle speed.

⚠ CAUTION

When occur any trouble, the best way is to consult your Hyosung dealer for repairs.

WHEN KEEPING FOR LONG PERIOD

1. Supply the enough fuel in the fuel tank.
2. Do drain wholly the fuel in the carburetor.
3. Remove the battery from the motorcycle.

CLEANING PROCEDURE

A thorough cleaning of your motorcycle is a necessary part of maintenance and will help keep your motorcycle looking and performing its best. Proper cleaning can also extend the life of your motorcycle.

It is important to clean and inspect your motorcycle after every ride if it is used in mud, brush, grass, water, salt water, or very dusty conditions.

The build-up of mud, brush, grass, etc, especially on the engine and exhaust system, can reduce engine cooling, conceal damage, or increase wear of certain parts. It is important to remove all debris during cleaning.

CAUTION

High pressure washers can damage your motorcycle.

High pressure washers such as those found at coin-operated car washes have enough pressure to damage the parts of your motorcycle. It may cause rust, corrosion and increase wear.

Do not use high pressure washers to clean your motorcycle.

⊙ WASHING YOUR motorcycle

With some care, your motorcycle can be washed in a similar manner to washing an automobile.

N O T E

Avoid spraying or allowing water to flow over the following places :

- Spark plug
- Fuel tank cap
- Carburetor

Use a garden hose at low pressure to remove the majority of dirt or other debris. Hand wash your motorcycle with a mild soap or detergent and water. Try to thoroughly remove all dirt and debris without excessive water pressure. Cloth rags, washing mitts or cleaning brushes can be used, be careful with brushes as they may scratch plastic or painted surfaces. Rinse the motorcycle thoroughly with clean water. Dry all areas using a chamois or soft absorbent cloth.

⊙ INSPECTION AFTER CLEANING

Remove the rags or wrapping from the exhaust pipe. For extended life of your motorcycle, lubricate according to “LUBRICATION POINTS” section.

WARNING

Operating motorcycle with wet brakes can be hazardous.

Wet brakes may not provide as much stopping power as dry brakes. This could lead to an accident.

Test your brakes after washing motorcycle, while riding at slow speed. If necessary, apply brakes several times to let friction dry out the pads.

Follow the procedures in the “INSPECTION BEFORE RIDING” section to check your motorcycle for any problems that may have arisen during your last ride.

LABEL

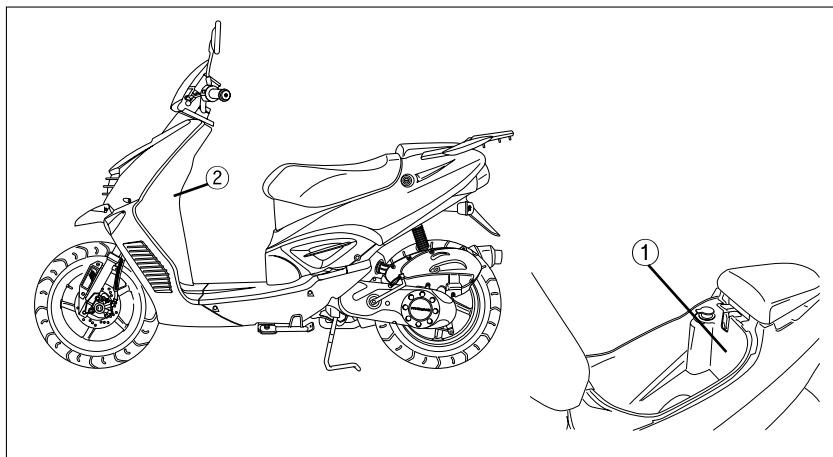

CAUTION

- Do not put something to be affected easily by the heat because the inside of trunk may be hotted.
- Do not put a valuables or a fragiles in the trunk.
- Make sure the seat were locked.

In case of riding with un-locked and it can cause an abnormal riding or dangerous in an emergency.

- Make sure the level of 2 stroke engine oil when you feed oil.
The driving without oil may cause a engine trouble.
- Use the hyosung genuine oil.
- Before riding, inspect the tire pressure, damage, abnormal wear and etc. according to the "Inspection before riding"
- Be careful not to be entered water into the trunk and also be careful of something important in the trunk.
- Do not use spurious gasoline. It can cause a serious damage in engine.

①

6832HN3250-PL

WARNING

- ▶ BE FULLY AWARE OF THE OWNER'S MANUAL BEFORE OPERATING AND RIDING.
- CERTAINLY WEAR A HELMET.
- OBSERVE THE OBSTRUCTED SPEED.
- DO NOT BE TOUCHED THE MUFFLER BECAUSE IT IS HOT.
- DO NOT DO ILLEGAL MODIFICATION FOR THE SAFER RIDING.
- ▶ MAX LOADING WEIGHT.
 - 1. TRUNK : 10kg
 - 2. REAR CARRIER : 5kg

● OPERATE THE INSPECTION AND THE MAINTENANCE ACCORDING TO THE REGULAR CHECKLIST OF THE OWNER'S MANUAL.

▶ THE CHECKLIST BEFORE RIDING (DASHBOARD, HORN, LAMP, OIL, BRAKE, TIRE)

TIRE PRESSURE	FRONT	REAR
FR 1 PERSON	180psil(1.25kg/cm ²)	290psil(2.00kg/cm ²)
FR 2 PERSONS	225psil(1.75kg/cm ²)	330psil(2.25kg/cm ²)
SIZE	120/90-10 66J	130/90-10 70J

②

6651BHN3250-PL

SPECIFICATIONS

DIMENSIONS AND DRY MASS

Overall length	1,840mm (72.4in)
Overall width	635mm (25.0in)
Overall height	1,110mm (43.7in)
Wheelbase	1,270mm (50.0in)
Ground clearance	125mm (4.9in)
Dry mass	94kg (207lbs)

ENGINE

Type	Two-stroke, forced air cooled
Intake system	Reed valve
Number of cylinder	1
Bore	41.0mm (1.614in)
Stroke	37.4mm (1.472in)
Piston displacement	49 _{cm³} (3.0 _{in³})
Corrected Compression ratio	7.4 : 1
Carburetor	SIDEDRAFT VARIABLE VENTURI(PISTON)
Starter system	KICK/ELECTRIC STARTER

TRANSMISSION

Clutch	Dry shoe, automatic, centrifugal type
Reduction ratio	2.997 ~ 0.813
Drive system	V-belt drive

CHASSIS

Front suspension	Telescopic type
Rear suspension	Coil spring type
Caster	25°
Trail	75mm (2.95in)
Steering angle	45° (right & left)
Front tire size	120/90-10 66J
Rear tire size	130/90-10 70J
Front brake	Disk
Rear brake	Drum

ELECTRICAL

Ignition type	"CDI" type
Ignition timing	23° B.T.D.C.at 1,000 rpm
Spark plug	BR8HSA
Battery	12V 4Ah
Generator	Magneto
Fuse	10A
Head lamp	HI : 35W / LO : 35W
Turn signal lamp	21W × 2 + 10W × 2
Brake/Tail lamp	21/5W
Speedometer lamp	3.4W
Oil indicator lamp	1.7W
Turn signal indicator lamp	1.7W
Fuel indicator lamp	1.7W
High beam indicator lamp	1.7W

CAPACITIES

Fuel tank	4.3 ℓ
Engine oil tank	1.0 ℓ
Transmission oil	110cc (Replace) 130cc (Overhaul)

CONSUMER INFORMATION

HYOSUNG MOTORS & MACHINERY INC.

77, SUNGSAN-DONG, CHANGWON-SHI,
KYUNGNAM, SOUTH KOREA

REPORTING OF SAFETY DEFECTS

If you believe that your vehicle has a defect which could cause a crash or could cause injury or death, you should immediately inform the National Highway Traffic Safety Administration (NHTSA) in addition to notifying Hyosung Motors & Machinery Inc.

If NHTSA receives similar complaints, it may open an investigation, and if it finds that a safety defect exists in a group of vehicles, it may order a recall and remedy campaign.

However, NHTSA cannot become involved in any individual problems between you, your dealer, or Hyosung Motors & Machinery Inc.

To contact NHTSA, you may either call the Auto Safety Hotline toll-free at 1-800-424-9393 (366-0123 in Washington, D.C. area) or write to :

**NHTSA
U.S. DEPARTMENT of TRANSPORTATION
400 7th Street SW, (NSA-11)
Washington, D.C. 20590.**

You can also obtain other information about motor vehicle safety from the Hotline.

MEMO



Prepared by

HYOSUNG MOTORS & MACHINERY INC.

1st Ed. NOV. 2003.

Printed in KOREA